

# BENINCA®

CENTRALE DI COMANDO

**CONTROL UNIT**

STEUEREINHEIT

**CENTRALE DE COMMANDE**

CENTRAL DE MANDO

**CENTRALKA STEROWANIA**

## HEAD

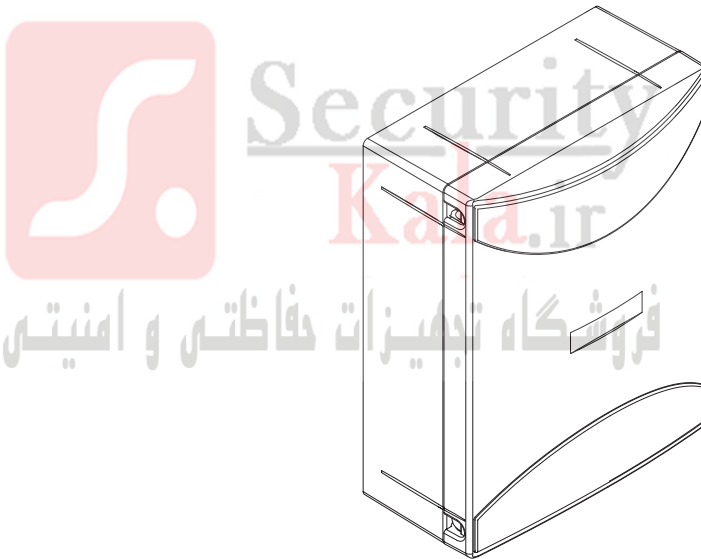

Libro istruzioni

**Operating instructions**

*Betriebsanleitung*

**Livret d'instructions**

Manuale de instrucciones

**Książeczka z instrukcjami**



UNIONE NAZIONALE COSTRUTTORI  
AUTOMATISMI PER CANCELLI, PORTE,  
SERRANDE ED AFFINI

**Dichiarazione CE di conformità**  
**EC declaration of conformity**  
**EG-Konformitätserklärung**

**Déclaration CE de conformité**  
**Declaracion CE de conformidad**  
**Deklaracja UE o zgodności**

Con la presente dichiariamo che il nostro prodotto  
 We hereby declare that our product  
 Hiermit erklären wir, dass unser Produkt  
 Nous déclarons par la présente que notre produit  
 Por la presente declaramos que nuestro producto  
 Niniejszym oświadczamy że nasz produkt

#### Head

è conforme alle seguenti disposizioni pertinenti:  
 complies with the following relevant provisions:  
 folgenden einschlagigen Bestimmungen entspricht:  
 correspond aux dispositions pertinentes suivantes:  
 satisface las disposiciones pertinentes siguientes:  
 zgodny jest z poniżej wyszczególnionymi rozporządzeniami:

Direttiva sulla compatibilità elettromagnetica (89/336/  
 CCE, 93/68/CEE)  
 EMC guidelines (89/336/EEC, 93/68/EEC)  
 EMV-Richtlinie (89/336/EWG, 93/68/EWG)  
 Directive EMV (89/336/CCE, 93/68/CEE) (Compatibilité  
 électromagnétique)  
 Reglamento de compatibilidad electromagnética (89/336/  
 MCE, 93/68/MCE)  
 Wytuczna odnośnie zdolności współdziałania elektromagne-  
 tycznego (89/336/EWG, 93/68/EWG)

Norme armonizzate applicate in particolare:  
 Applied harmonized standards, in particular:  
 Angewendete harmonisierte Normen, insbesondere:  
 Normes harmonisées utilisées, notamment:  
 Normas armonizadas utilizadas particularmente:  
 Normy standard najczęściej stosowane:

EN 55022, EN 61000-3-2, EN 61000-3-3, EN 50082-1

Data/Firma

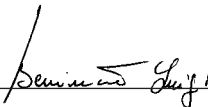

Direttiva sulla bassa tensione (73/23/CEE, 93/68/CEE)  
 Low voltage guidelines (73/23/EEC, 93/68/EEC)  
 Tiefe Spannung Richtlinie (73/23/EWG, 93/68/EWG)  
 Directive bas voltage (73/23/CEE, 93/68/CEE)  
 Reglamento de bajo Voltaje (73/23/MCE, 93/68/MCE)  
 Wytuczna odnośnie niskiego napięcia (73/23/EWG, 93/  
 68/EWG)

Norme armonizzate applicate in particolare:  
 Applied harmonized standards, in particular:  
 Angewendete harmonisierte Normen, insbesondere:  
 Normes harmonisées utilisées, notamment:  
 Normas armonizadas utilizadas particularmente:  
 Normy standard najczęściej stosowane:

EN 60204-1, EN 60335-1

Data/Firma

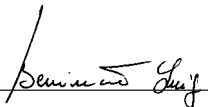

**BENINCA®**

Automatismi Beninca Srl  
 Via Capitello, 45  
 36066 Sandrigo (VI)  
 ITALIA

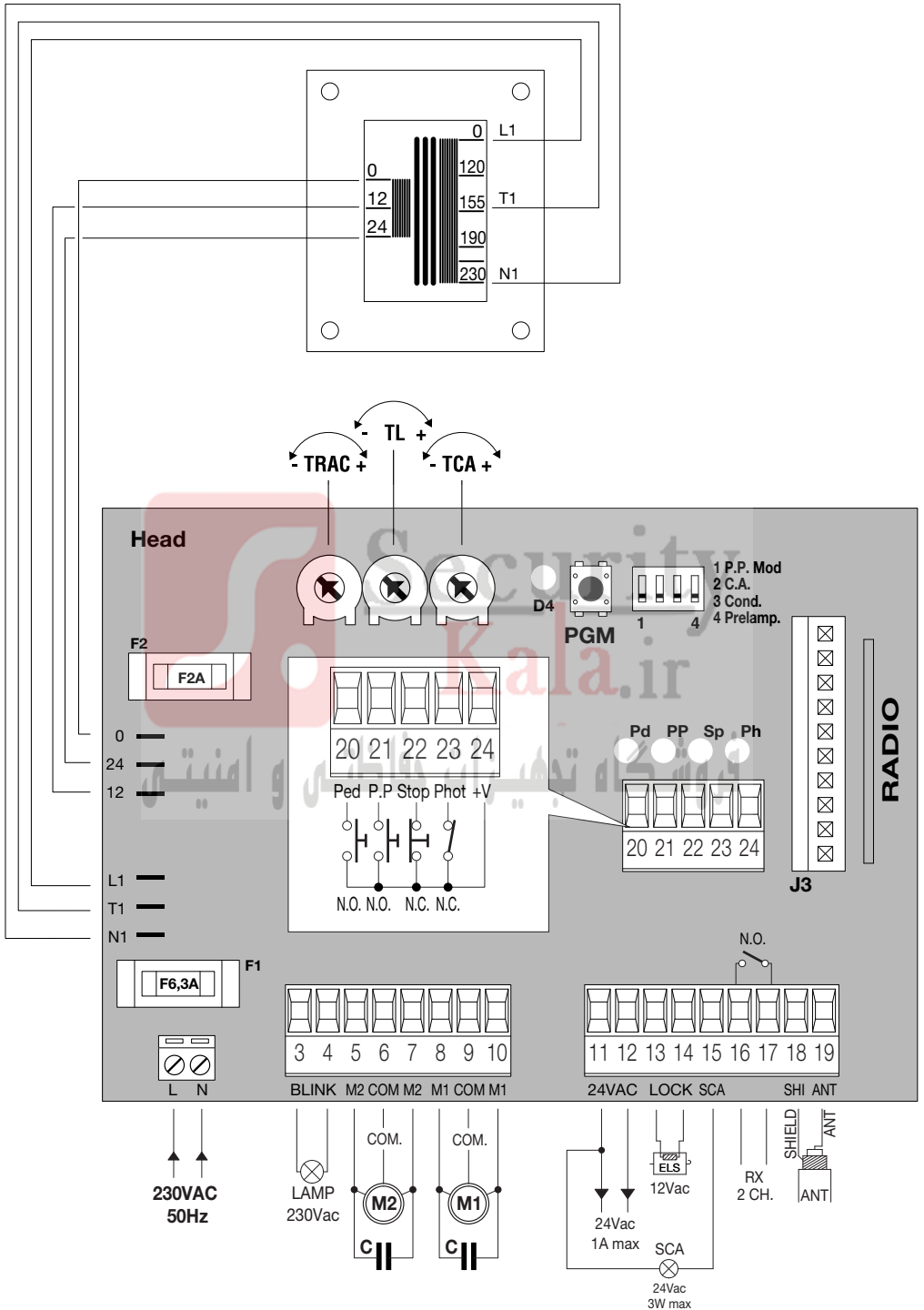

## HEAD Control Unit

The electronic control unit HEAD can be used to control 2 motors with a power not exceeding 350+350W.

### GENERAL WARNINGS

- The wire connections and the operating logic should be in compliance with regulations in force.
- The cables featuring different voltage should be physically detached, or adequately insulated by an additional insulation of at least 1 mm.
- The cables should be further fastened in proximity to the terminals.
- Check all connections before powering the unit.
- Check that settings of the Dip-switches are the required ones.
- The N.C. inputs which are not in use should be short-circuited.

### INPUT/OUTPUT FUNCTIONS

Terminal No.	Function	Description
1-2	Power supply	Input, 230Vac 50Hz (1-Phase/2-Neutral)
3-4	Flashing light	Output, flashing light connection, 230Vac 40W max.
5-6-7	Motor 2	Connection to motor 2 : (5-move/6-Com/7-move)
8-9-10	Motor 1	Connection to motor 1 : (8-move/9-Com/10-move) – delayed in closing phase. If only one motor is used, connect Motor 1 output and adjust TRAC to the minimum value.
11-12	24 Vac	Output, accessories power supply 24Vac/1A max.
13-14	Electric lock	Electric lock connection, 12Vac/0,5A max.
11-15	SCA	Open gate indicator light connection, 24 Vac/3W max.
16-17	RX 2ch.	Output, second radio channel, N.O. contact, voltage free. It is enabled with both fixed receiver and expandable two-channel receiver
18-19	Aerial	Aerial connection, radio receiver card and incorporated radio module (18-screen/19-signal).
20	Pedestrian	Input, N.O. pedestrian push-button Activation is carried out on motor M1 (8-9-10)
21	Step-by-Step	Input, N.O. step-by-step push-button
22	STOP	Input, N.C. STOP push-button
23	PHOT	Input, safety devices connection, N.C. terminal (e.g. photocells)
24	+V	Common to all control inputs.
25-26-27	0-24-12	Connection to transformer secondary winding
28-29-30	L1-T1-N1	Connection to transformer primary winding
J3	Radio receiver	Connector for two-channel radio receiver (optional)

#### To check connections:

- Cut-off power supply.
- Manually release the wings, move them to approx. half-stroke and lock them again.
- Reset power supply.
- Send a step-by-step control signal by pressing the button or the remote control key.
- The wings should start an opening movement. If this is not the case, invert the movement wires of the motor. (8/10 for motor M1, and 5/7 for motor M2).
- Adjust Time, Operating Logic and Motor Power.

#### To adjust the motor power

**WARNING! This adjustment affects the safety of the automatic system.**

**Check that the thrust applied onto the wing complies with regulations in force.**

A Faston (T1) connector is provided on the power supply transformer which allows the power adjustment of the motors on 4 different levels. By moving the Faston (T1) to 120, power is at minimum, by moving it to 230, power is at maximum.

**Position 230 can be used only with motors complete with adjustable mechanical clutch.**

**In any case, check compliance with regulations in force.**

#### Functions of Trimmers

<b>TCA</b>	The automatic closure time can be adjusted with this trimmer. Check Dip-switch N°2= On. This function can be adjusted between 1 s minimum and 125 s maximum
<b>TL</b>	The maximum time of the opening and closing phases can be adjusted with this trimmer. Time should be preset approx. 4 sec. longer than the actual stroke time of the automatic system. Adjustment ranges from 5 s minimum to 130 s maximum Note: In the event of partial opening/closing, the control unit calculates the remaining time to complete the operation in order to avert useless overheating of the motor.
<b>TRAC</b>	It allows to adjust the delay time with which motor 1 starts closing with respect to motor 2. Adjustment range from 3 s minimum to 30 s maximum. During opening, the out of phase time of the motors is 2 seconds.

#### Dip-Switch functions

<b>DIP 1</b>	“P.P. Mod”	The operating mode of “Pulsante P.P.” (Step-by-step push button) and of the transmitter is selected. Off: operation : APRE > STOP > CHIUDE > STOP > On: operation: APRE > CHIUDE > APRE >
<b>DIP 2</b>	“C.A.”	Automatic closure is enabled or disabled. Off: disabled automatic closure On: enabled automatic closure
<b>DIP 3</b>	“Cond.”	The multi-flat function is enabled or disabled. Off: disabled multi-flat function. On: enabled multi-flat function. The P.P. (Step-by-step) impulse or the impulse of the transmitter have no effect in the opening phase.
<b>DIP 4</b>	“Prelam.”	Forewarning flashing light enabled or disabled Off: disabled forewarning flashing light On: enabled forewarning flashing light. The flashing light is activated 3 s before the motor starts.

**Note: After modifying the setting of trimmers and Dip-Switches, switch off and power the unit again.**

#### Configuration of the built-in receiver

The control unit is complete with an incorporated radio receiver for both fixed-code and variable code radio controls, at 433.92MHz frequency.

To use a radio control, its code should be copied first. The memorization procedure is shown here under. The device is able to store up to 14 different codes in memory.

#### Memorization of a new transmitter with activation of the P.P. (step-by-step) function

- Press PGM button once for 2 seconds, the D4 LED starts flashing rapidly.
- Within 10s, press the transmitter push-button which should be stored in memory with P.P. function.

#### Memorization of a new transmitter with activation of 2nd radio channel output (Terminals 16-17)

- Press button PGM twice, each time for at least 2 seconds, the D4 LED switches on with fixed light.
- Within 10s, press the transmitter push-button which should be stored in memory with 2nd radio channel function.

To exit the programming mode, wait for 10s or press the PGM button for 2 seconds, the D4 LED flashes regularly again.

#### To delete the control unit codes from memory

- Cut-off power supply to the control unit
- Reset power supply by keeping the PGM button pressed for 5 seconds; the D4 LED switches on with fixed light and then off when deletion is completed.
- Release the PGM button, memory is deleted and the D4 LED starts flashing regularly again.

NOTE: If the D4 LED switches on with two long flashes and then switches off, when entering the transmitter codes memorization mode, this means that the receiver is full and no other transmitter code can be stored in memory.

### LED diagnostics

The control unit is complete with a series of self-diagnostics LED's which allow checking of all functions:

LED PD	It switches on when the pedestrian push-button is activated
LED PP	It switches on when the step-by-stop push-button is activated
LED SP	It switches off when the STOP push-button is activated
LED PH	It switches off when photocells are not aligned or when obstacles are present
LED D4	Programming of radio-controls. It is usually flashing to indicate the regular operation of the control unit.

### Advanced programming

The advanced programming permits to activate some special functions:

1) **Photocells input, activated in both opening and closure on terminal 22.**

In swing gates, it might be useful to connect the inside photocells (columns) to this terminal and connect the outside photocells to input PHOT (terminal 23).

In this way, the gate opening movement is impaired if the inside photocells detect the presence of an obstacle. The outside photocells remain, as usual, activated only in the closing phase.

2) **Rapid closure activation.** If the photocells are passed by, this function carries out the gate closure after 3s, without considering the TCA time. The 2 "CA" Dip-Switch should be positioned to ON.

3) **Radio receiver enabled only to variable code transmitters.** Any possible programmable code transmitters which have been previously installed remain stored in the receiver memory but are deactivated.

To activate the advanced functions, proceed as follows:

- 1 - Press the PGM button for 2 seconds and then release it - the D4 LED light flashes rapidly
- 2 - Press the PGM button for 2 seconds and then release it - the D4 LED light stays switched on
- 3 - Press the PGM button and keep it pressed - the D4 LED flashes three times and then a pause follows
- 4 - Within 30s, keeping the PGM button pressed, carry out the enabling of the special functions by using the following Dip-Switches :

**DIP 1 "STOP/PHOT Opn/Cls".** The operating mode of input 22 is selected with this Dip-Switch.

On: Terminal 22: Input, photocell activated in both opening and closure

Off: Terminal 22: Input, STOP push-button

**DIP 2 "Rapid closure"** . This automatic closure is enabled or disabled by this Dip-Switch.

On: Enabled rapid closure

Off: Disabled rapid closure

**DIP 3 "Radio"** . This enables or disables the programmable code transmitters.

On: Radio receiver, enabled exclusively for variable code transmitters.

Off: Receiver, enabled for variable code and programmable code transmitters.

At end of 30 seconds, the D4 LED stays on, the control unit reads out the position of Dip-Switches 1/2/3 and enables or disables the advanced functions.

5 - Release the PGM button - **Move the Dip-Switches to the original position.**

6 - Cut-off mains power supply and power the unit again.

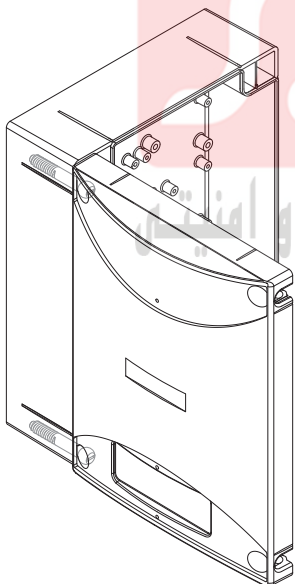
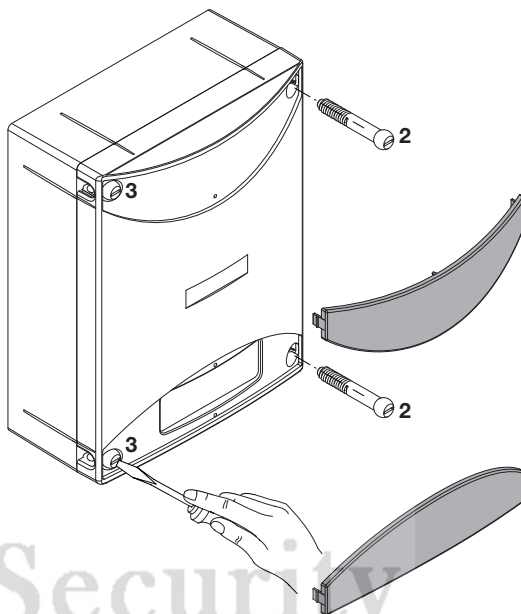
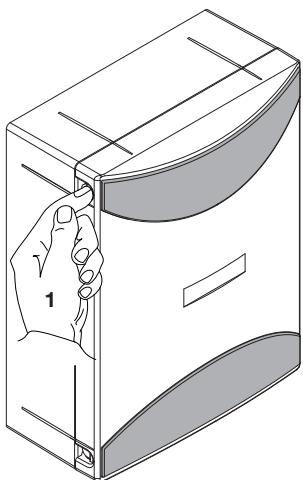

- 1 Premere le alette sui fianchi per sganciare le due maschere copriviti.
- 2 Rimuovere le due viti sul lato di apertura desiderato.
- 3 Allentare le due viti con funzione di cerniera senza rimuoverle, in modo da consentire l'apertura del coperchio.

- 1 Press the tabs on the sides to release the two masks that cover the screws.
- 2 Remove the two screws on the desired opening side.
- 3 Slacken the two screws that act as a hinge without removing them, so as to allow opening of the cover.

- 1 Presser les deux ailettes latérales pour décrocher les deux cache-vis.
- 2 Enlever les deux vis sur le côté d'ouverture désiré.
- 3 Desserrer les deux vis faisant fonction de charnière sans les enlever, de manière à permettre l'ouverture du couvercle.

- 1 Presionar las aletas en los lados para desenganchar las dos tapas cubretornillos.
- 2 Extraer los dos tornillos del lado de apertura deseado.
- 3 Aflojar los dos tornillos con función de bisagra sin extraerlos, a fin de poder abrir la tapa.

- 1 Auf die seitlichen Laschen drücken, so dass die beiden Schraubenblenden befreit werden.
- 2 Die beiden Schrauben an der gewünschten Öffnungsseite ausbauen.
- 3 Zuletzt die beiden als Scharnier dienenden Schrauben lockern, aber nicht ausbauen, damit der Deckel geöffnet werden kann.

- 1 Nacisnąć boczne klapki w celu odhaczenia dwóch masek nakrywających śruby.
- 2 Wyciągnąć dwie śruby po wybranej do otwierania stronie.
- 3 Poluzować dwie śruby blokujące bez wyciągania ich, w sposób umożliwiający otwarcie nakrywki.

# BENINCA®